

N6.325 CR2

SPECIFICATIONS

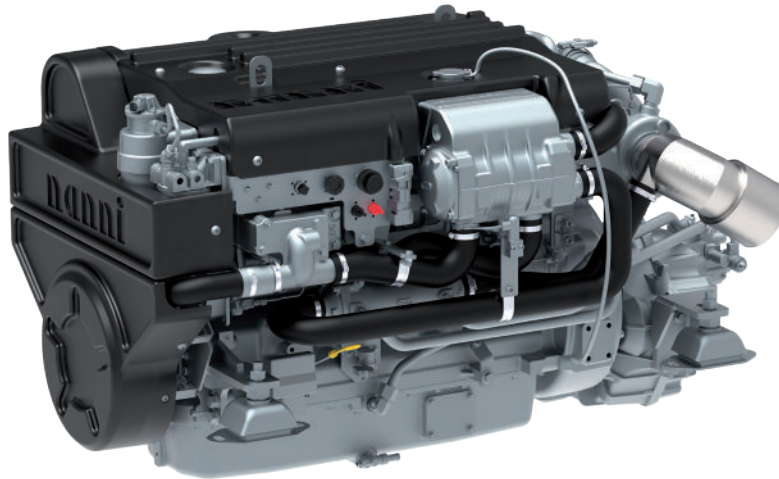

Power at crankshaft	239 kW [325 hp]	Engine base	John Deere
Displacement	6.8 l [415 in ³]	Fuel system	Direct injection High pressure Common Rail Electronically controlled
Configuration	6 cylinders in line	Air intake	Turbocharged Air-to-seawater aftercooler
Operation type	4 strokes Diesel	Cooling	Closed cooling with heat exchanger
Bore & Stroke	106.4 x 127 mm [4.19 x 5 in]	Max mounting angle	0° Front down 12° Front up
Compression ratio	16.3 : 1	Alternator	24 Volt 50 Amp
Rated speed	2600 rpm	Rating	M3
Idling speed	600 rpm	Emission compliance	IMO Marpol Annex VI NRMM (97/68/EC) Tier 3 EPA marine Tier 3 RCD2 2013/53/EU
Peak torque	1137 Nm	Dry weight	735 kg [1620 lbs]
Peak torque speed	1900 rpm		

N6.325 CR2

239 kW [325 hp] at 2600 rpm

TECHNICAL DESCRIPTION

ENGINE BLOCK

- Replaceable wet-type cylinder liners
- 4 Valves per cylinder
- Watercooled exhaust manifold

FUEL SYSTEM

- Primary & secondary fuel filter
- Fuel heater
- Common Rail fuel injection system

LUBRICATION SYSTEM

- Replaceable full-flow oil filter
- Oil dipstick
- Oil cooler

COOLING SYSTEM

- Closed cooling with heat exchanger
- Gear driven self-priming raw water pump
- Coolant circulating pump
- Water cooled exhaust elbow

ELECTRICAL SYSTEM & INSTRUMENTATION

- 24V / 50A alternator
- 24V starter motor
- Complete instrumentation including key switch and alarms
- Extension cable harness with plug-and-play

AIR INTAKE

- Turbocharged
- Air-to-seawater aftercooler

OTHER FEATURES

- Flywheel SAE 3
- Flexible engine mounting
- Damper pulley

OPTIONAL SYSTEMS & ACCESSORIES

- Keel cooling adaptation
- Dry exhaust elbow
- Complete marine propulsion systems
- Marine transmission adaptation kits
- Throttle and shift controls
- Additional instrumentation, Flying bridge extension harness
- Rigid engine mounting
- Power take off

RATINGS

- Up to 4000 annual operating hours
- Load factor up to 50%
- Full power for no more than 4 hour out of 12 hours of operation. The remaining operation time must be at or below cruising speed

TRANSMISSIONS

- Contact your Nanni representative for more details and availability about transmissions types and models range.

PERFORMANCE CURVES

POWER AT CRANKSHAFT

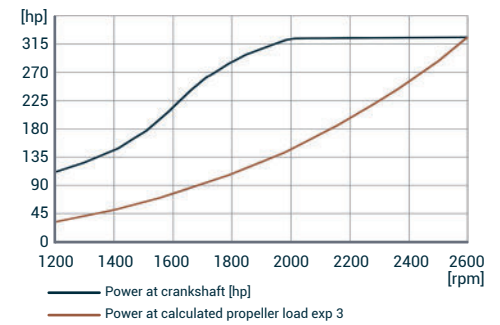

TORQUE AT CRANKSHAFT

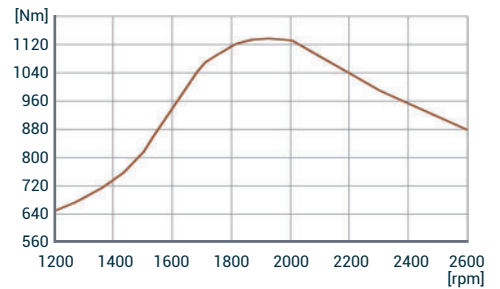

FUEL CONSUMPTION

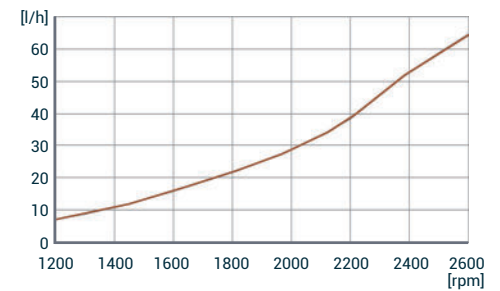

DIMENSIONS

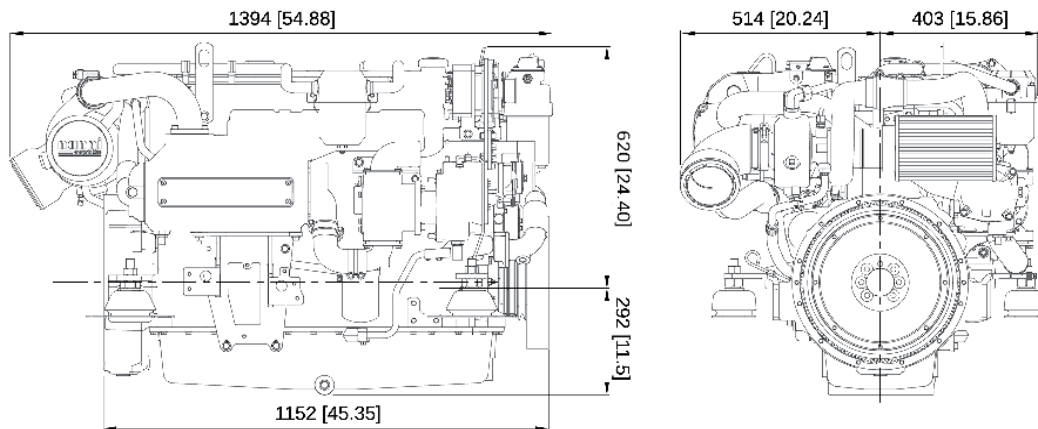

NANNI INDUSTRIES S.A.S.

11, Avenue Abbé Mariotte
33260 La Teste - France
Tel +33 (0)5 56 22 30 60
www.nannienergy.com

NANNI SRL

Via degli Olmetti, 44/A
00060 Formello - Roma - Italia
Tel +39 06 30 88 42 51
www.nannienergy.com

Technical data according to ISO 8665. This document is not contractual. Nanni reserves the right to modify any of the characteristics stated in this document without notice, in a constant effort to improve the quality of its products. Images and illustrations may show non standard equipments. All combination of equipment & accessory are not available.

DGBXXC01035B